

Maxiroll Greenline



GB
630/830 cm

Maxiroll Greenline

Type 630 cm

Congratulations on your new Maxiroll Greenline. To ensure **safe operation** and to obtain optimal use of the machine, read the rules and instructions of the following operator's manual carefully before **operating the machine**.

©Copyright 2002, DAL-BO. All rights reserved.

Your Maxiroll Greenline:

Type No.: _____ Serial No.: _____
Month of manufacture: _____ Net weight (kg): _____

For prompt service, always quote your machine serial number when making enquiries regarding spare parts or service. A comprehensive index of spare parts can be found in the back of this manual to give you an overview of Maxiroll Greenline components and to facilitate ordering.

EU DECLARATION OF CONFORMITY

Maskinfabriken DAL-BO A/S
DK-7183 Randbøl

Hereby declare that the above-mentioned machine has been manufactured in compliance with the provision of the Council Directive on the approximation of the laws of the Member States relating to machinery 98/37/EC, which replaces Council Directive 89/392/EEC and amendments 91/368/EEC, 93/44/EEC and 93/68/ECC concerning the Essential Health and Safety Requirements for the design and manufacture of Machinery.

CE

This machine complies with the safety requirements stipulated by the European safety regulations.

Maskinfabriken DAL-BO A/S

Date: _____

Director Kaj Pedersen

Table of Contents

SAFETY	7
GENERAL	7
HYDRAULIC SYSTEM.....	8
HITCHING.....	8
MAINTENANCE AND REPAIRS.....	8
TRANSPORT.....	9
CORRECT USE	9
TECHNICAL DATA	10
HOW TO USE THIS MANUAL	11
DELIVERY	11
APPLICATION.....	12
HITCHING AND UNHITCHING.....	13
HITCHING.....	13
HYDRAULIC SYSTEM.....	13
UNHITCHING	14
ADJUSTMENTS AND SETTINGS	15
ADJUSTING HITCH HEIGHT.....	15
<i>Adjustable hitch.....</i>	<i>15</i>
<i>Adjusting the middle section.....</i>	<i>16</i>
ADJUSTING WING FOLD STOP.....	17
REFILLING WATER.....	17
<i>Draining water.....</i>	<i>17</i>
OPERATING AND DRIVING INSTRUCTIONS.....	18
UNFOLDING AND FOLDING	18
<i>Unfolding</i>	<i>18</i>
ADJUSTING HYDRAULIC WEIGHT TRANSFER	19
<i>Too much pressure</i>	<i>21</i>
<i>Too little pressure</i>	<i>21</i>
TRAVEL SPEED	21
<i>Power requirements</i>	<i>21</i>
TROUBLESHOOTING	22
OPTIONS.....	23
CRACKERBOARD	23
<i>Power requirements</i>	<i>23</i>
<i>Hose markings.....</i>	<i>24</i>
<i>Adjusting tine angle</i>	<i>24</i>
<i>Fine adjustment of Crackerboard and weed harrow sections.....</i>	<i>24</i>
<i>Operating and driving instructions.....</i>	<i>25</i>
<i>Mounting after delivery.....</i>	<i>26</i>

<i>Locking Kit</i>	27
COMB, SUPPORT WHEEL, MOLEBOARD	28
MAINTENANCE	29
LUBRICATION.....	29
ADJUSTMENT	30
<i>Wheels</i>	30
<i>Wearing points</i>	30
SCRAPERS	30
SCRAPERS	30
HYDRAULIC SYSTEM.....	31
REPLACEMENTS AND REPAIRS	32
HYDRAULIC SYSTEM	32
<i>Changing wing fold cylinders</i>	32
<i>Replacing wing fold cylinder seals</i>	33
<i>Assembly</i>	34
<i>Changing tilting cylinder</i>	34
<i>Replacing tilting cylinder seals</i>	35
<i>Assembly</i>	35
<i>Changing Crackerboard depth adjustment cylinder</i>	36
<i>Replacing depth adjustment cylinder seals</i>	36
<i>Assembly</i>	37
DISMOUNTING/MOUNTING OF WHEELS	37
<i>Changing wheel bearings</i>	37
DISMOUNTING STEEL CYLINDER	38
<i>Changing wing steel cylinder roller</i>	38
<i>Mounting</i>	39
<i>Changing the middle Steel cylinder roller</i>	39
SCRAPPING	40
HYDRAULIC SYSTEM DIAGRAM.....	41
SPARE PARTS	42

Safety



The safety alert symbol is used throughout this manual to identify important safety warning messages concerning your safety, the safety of other users or the functional safety of the implement. Observe all safety instructions and make them readily accessible to all users of the equipment.

General

- The operator must be thoroughly familiar with all safety precautions and operations of this equipment prior to using.
- The safety signs on the Maxiroll Greenline contain important instructions concerning your safety, the safety of those around you, and the correct operation of the machinery.
- Never allow anyone to ride on the implement during operation or transport.
- Never allow bystanders within the operating radius of the Maxiroll Greenline when the implement is in operation. Operate the Maxiroll Greenline only while seated in the driver's seat of the tractor.
- Ensure that wing section locks are engaged when the Maxiroll Greenline is in a folded position. Secure control levers against unintentional operation.
- Before performing any adjustments, maintenance or repairs on the machinery, always unfold the Maxiroll Greenline and lower the implement to the ground or secure in transport position, set the tractor brakes, turn off the engine and remove the ignition key.
- Remember to secure the drawbar stand and the lift arms (if applicable) with lynch pins.
- Operate the tractor and Maxiroll Greenline only while seated in the driver's seat.
- Always drive according to conditions.
- Do not use the Maxiroll Greenline unless all safety signs are installed. Replace defective safety signs immediately.

Hydraulic System

- Before performing maintenance or repairs on the hydraulic system, lower the implement to the ground, relieve pressure in the system, turn off the engine and remove the ignition key.
- Clean the hydraulic fittings thoroughly before connection. Ensure that the pressure is relieved in the hydraulic system before connecting the hydraulic hoses to the tractor's hydraulic services.
- Completely removing the pressure in hydraulic systems with built-in pilot-operated check valves can be difficult. Always hold a cloth around the fittings/parts to be removed to prevent oil under pressure from escaping.
- After making repairs to the hydraulic system, thoroughly bleed air out of the system.
- Regularly check hydraulic hoses for defects such as cracks, bends, chafing or leaks.
- Avoid spilling oil on the ground. In case of spills, collect the oil and dispose of it properly.
- In case skin should come in contact with hydraulic oil or grease or in case clothing should become stained with oil, remove the stained clothes immediately and wash the affected skin areas thoroughly. Oil and grease are harmful to the skin.
- Escaping hydraulic oil under high pressure can penetrate the skin and cause severe injury. If an accident occurs, see a doctor immediately.

Hitching

- An individual is in danger of being crushed during the hitching process. Never place yourself or anyone else between the tractor and the Maxiroll Greenline, or between parts that must be attached or connected.

Maintenance and Repairs

- Before servicing or making adjustments to the machine, securely block or unfold the machine, engage the tractor and machine brakes, stop the engine and remove the keys.
- Tighten all nuts, bolts hydraulic fittings or any other fastened assemblies after a few hours' use. Check often to make sure that they remain thoroughly tightened. Inspect all pins, screws and bolts for wear or damage and make sure that all are securely in place to avoid any possible damage or breakdown of the machine.

- Dispose of oil, grease and filters according to applicable environmental regulations.

Transport

- All safety and warning signs and devices required by law must be displayed, mounted and tested for public road use. The driver is responsible for the correct use of lights and markings in compliance with the present Traffic Act and Highway Code of the local traffic legislation.
- It is the responsibility of the driver to consult with local traffic authorities in order to ensure that the size, weight and load of the machinery may be transported on public roads.
- When towing the implement, the total weight of the tractor and the maximum allowed axle load must not be exceeded. The weight on the front axle must not be less than 20 percent of the total mass of the tractor. If it is less than 20 percent, extra weight must be added to the front of the tractor.

Correct Use

- Correct use of the Maxiroll Greenline includes adherence to the instructions of the manufacturer concerning operation, maintenance and repair, as well as the use of genuine factory replacement parts.
- Do not allow anyone to operate, maintain or repair the Maxiroll Greenline unless they are familiar with the implement and they are thoroughly aware of the possible hazards.
- The manufacturer does not accept any liability for injury or warranty if the equipment has been altered in any way without prior authorization from the manufacturer or if the injury is a result of incorrect use of the implement. The user accepts complete responsibility in these cases.
- Never load extra weight onto the Maxiroll Greenline.

Technical Data

Maxiroll Greenline

Size (cm)	630
HP (recommended)	90-120
Gross weight (kg)	3250/5580
Sections (pc.)	3
Axles (pc.)	3
Wheels	400/60x15.5
Options	
Crackerboard (kg)	785
Weed-harrow (kg)	915
Seed equipment	

How to Use This Manual

If the order of points described under the main subject areas of the manual seems confusing or illogical, refer to the Table of Contents where all subject headings can be found.

The main points of the operator's manual are placed into five main categories:

- Safety
- Set-up and Operation
- Options
- Maintenance
- Repairs

The following safety alert symbols are used throughout this manual to indicate:



Points that are extremely important for the function and life of the machinery.



Points that involve safety.

Delivery

Maxiroll Greenline is delivered fully assembled on a flatbed lorry.

If the Maxiroll Greenline needs to be lifted, it is recommended that you lift with straps around the middle section, raising the machine so that it hangs in balance.

Application

The Maxiroll Greenline is an extra rugged roller and is developed to assist today's efficient farmer in achieving higher productivity from grass fields and paddocks.

The Maxiroll Greenline is a three-section roller with integrated hydraulic weight transfer, in which the sections move independently of each other.

Fig. 1



Maxiroll Greenline 630

Maxiroll Greenline can be equipped with optional attachments such as the hydraulic Crackerboard. Hydraulic operated two-row spring-tine weed-harrow with 12 mm tines and integrated seed technology enables new- or catch crop.

The Crackerboard is primarily used for levelling of soil and levelling of molehill etc. The weed harrow assists in soil aeration and levelling.

Hitching and Unhitching

Hitching

Attach the Maxiroll Greenline to the fixed drawbar of the tractor, positioning the drawbar eye of the Maxiroll Greenline (A) between the yoke end of the tractor drawbar.

Insert the hitch pin and raise the drawbar jack stand.

Fig. 2



- Remember to lock the hitch pin with a lynch pin or another proper locking pin.
- Remember to raise the drawbar jack stand.



- If the drawbar of the tractor is too short, the lift arms could collide with the jack stand of the roller when turning sharply to the right. To avoid this from occurring, extend the drawbar of the tractor.

Hydraulic System

The standard Maxiroll Greenline model requires one double- and one single acting hydraulic services. The double acting for wing folding and the single acting for raising/lowering (tilting) the roller.

Table 1. Hydraulic hose markings

Cylinder Name	Colour	Service	Function
Tilting cylinder	White	Single-acting	Raise Maxiroll Greenline up onto the wheels and lower it down into a working position.
Wing fold/ Weight transfer	Red	Double-acting	Fold wing sections in/out and transfer weight from the middle section to the wing sections.



- Wing fold/ weight transfer cylinder requires a hydraulic service with a floating position.
- Check the hydraulic hoses for kinks or pinches.

Unhitching

The Maxiroll Greenline must be completely folded up (in the transport position) or unfolded before unhitching.

Unscrew the drawbar stand, lifting the Maxiroll Greenline drawbar from the hitch of the tractor. Remove the hitch pin and disconnect the hydraulic hoses.



Remember to relieve the pressure in the hydraulic system before disconnecting the hoses.



For side section hydraulic outlets (marked red), moving the hydraulic handle into the floating position is not sufficient to remove pressure from the system. It is necessary to apply counter pressure (due to the built-in pilot-operated check valve).

Check the reading on the Maxiroll Greenline manometer.

Adjustments and Settings

The Maxiroll Greenline is preset in the factory, but it will always be necessary to make some fine adjustments before use. Numerous adjustment possibilities make your Maxiroll Greenline more versatile and allow you to obtain optimum performance from the implement.

Adjusting hitch height

To ensure an even distribution of pressure on the field, the frame tube of the middle section (A, Fig. 3) must be parallel to the ground, and the drawbar (B, Fig. 3) must be accurately aligned with the towing tractor. Various adjustment possibilities enable optimal setting.

Fig. 3

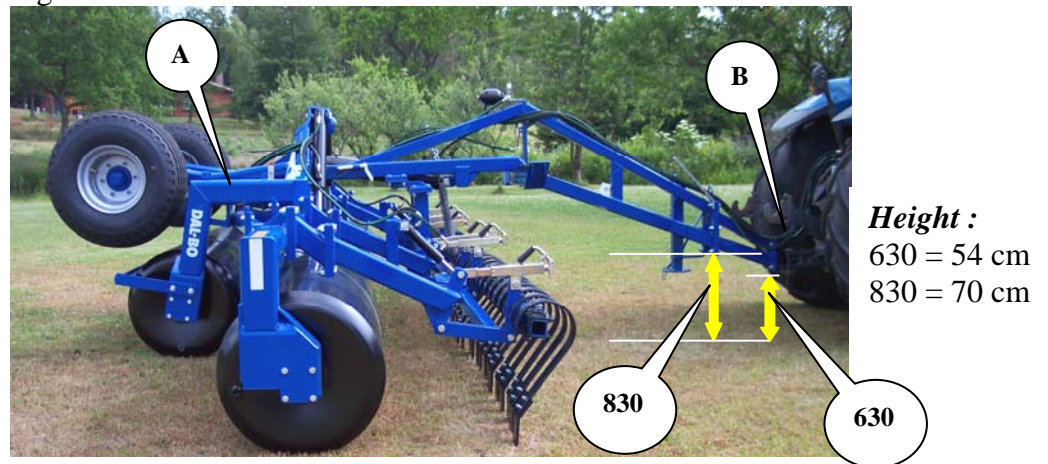

Adjustable hitch

Incorrect towing height results in an uneven packing of the field, as the roller will not pack the soil evenly on all the sections.

Fig. 4

To obtain optimal towing height, it is possible to reverse or move the drawbar end bracket so that the height of the drawbar eye matches that of your tractor hitch.

With Maxiroll Greenline resting on the jack stand, loosen bolts (A) and turn or move the end bracket.





If the Maxiroll Greenline is equipped with a Crackerboard or weed harrow, see "Fine adjustment of Crackerboard sections" under "Options".

Adjusting the middle section

With Maxiroll Greenline wing sections in an unfolded position (see "Operating and Driving Instructions"), check that the frame tube of the middle section (A, Fig. 3) is horizontal (parallel with the ground) when the bolts (A, Fig. 5) are touching the tube of the drawbar (B, Fig. 5).

Fig. 5

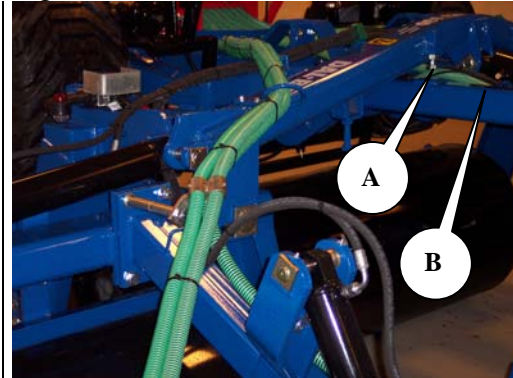

If the middle section is not parallel with the ground, adjust the bolts (A, Fig. 5).

1. Loosen the locking nut (B).
2. Adjust the bolt (C) up/down.
3. Tighten the locking nut (B).
4. Check that the frame is horizontal and that the towing height is correct.
5. The bolt (C) must touch the tube of the drawbar (B, Fig. 5), otherwise drive the tractor a little forward to check the settings.

Fig. 6

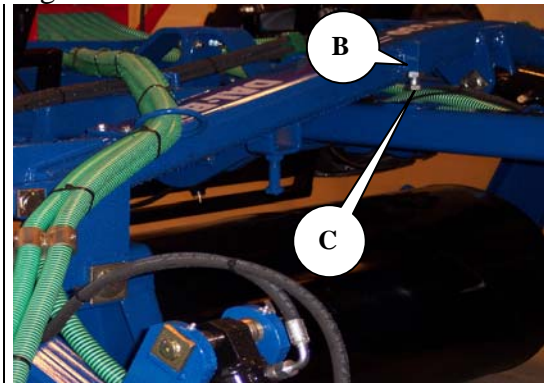

A pendulum (A) is provided on the middle section to serve as a guide for this adjustment. The pendulum must be flush with the adjacent fixed frame part.

Fig. 7

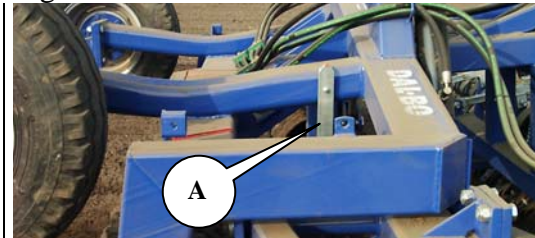

It is important to locate the Maxiroll Greenline on **level** ground in order to set the middle section correctly.

Adjusting wing fold stop

To ensure the correct transport position of the wing sections, it is possible to adjust the backstop (A) for the wing sections.

Fig. 8

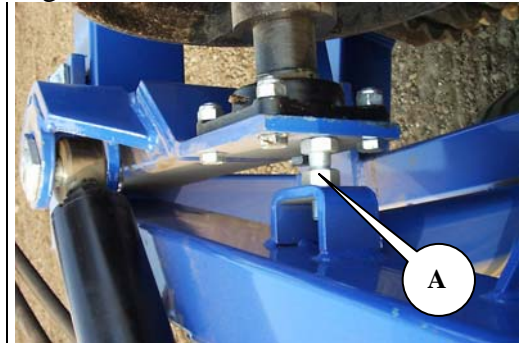

Refilling water

Rotate the steel cylinder roller until the plug faces upwards.

If you do not wish to fill the cylinder roller completely, turn the cylinder roller until water can flow out of the plug when it reaches the desired level.

Fig. 9

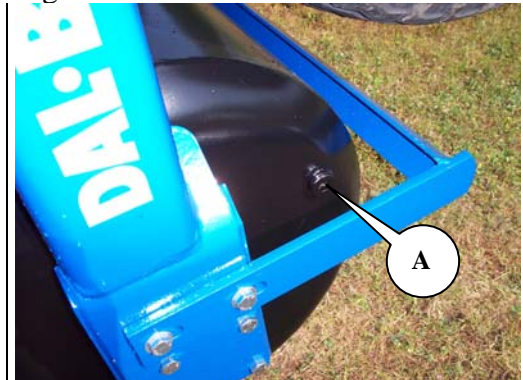

Ensure antifreeze level is sufficient to avoid freezing. If it is not, drain the water before exposing the unit to freezing temperatures.

Draining water

Plugs for draining and refilling water are located on either end of the steel cylinder roller. Rotate the roller until the plug is facing downwards. Remove the plugs with an 18 mm Allen key.



To drain the water faster, also remove the plug on the opposite side.

Operating and Driving Instructions

Proper operation is essential for optimum performance of your Maxiroll Greenline. Proper operation concerns both the carrying out of tillage operations in the field as well as the following of safety precautions. Make sure that you have a thorough understanding of all safety precautions.

Unfolding and Folding

Always unfold and fold the wings of the Maxiroll Greenline while the equipment is stationary and the tractor is parked.



When unfolding and folding with the Crackerboard or weed harrow, make sure that the Crackerboard and weed harrow is fully raised in the top position, since the tines could collide with each other (see "Options, Crackerboard").

Unfolding

- 1 Lift the wing sections out of the transport locks (A) using the tilting cylinder (marked white).

Fig. 10



- 2 Activate the wing fold cylinders (marked red) and completely unfold the wing sections.
- 3 Activate the tilting cylinder and lower the roller onto the ground.

Fig. 11



Before operating the roller, the weight transfer must be adjusted correctly (see "Adjusting hydraulic weight transfer").

Relieve the pressure of the weight transfer to the wing sections (see "Adjusting hydraulic weight transfer").



If Crackerboard or weed harrow is mounted, it must be fully raised to the top position before folding (see "Options, Crackerboard, Operating and driving instructions").

1. Activate wing fold cylinders (marked: red) to the fully extended position, so that the outermost ends of the wing sections (A) are raised.

Fig. 12

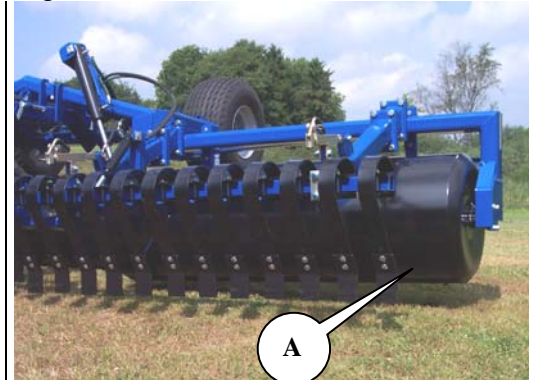

2. Activate the tilting cylinder (marked: white) to the fully extended position and raise the roller off the ground.

Fig. 13



3. Activate the wing fold cylinders again and fold the wings up (wing fold cylinders must be fully retracted).
4. Activate the tilting cylinder and lower the roller down into the transport locks.

Fig. 14



Adjusting hydraulic weight transfer

The hydraulic weight transfer system ensures the even distribution of weight across all sections of the roller.

1. With the roller in an unfolded position, relieve the pressure in the wing fold cylinder (marked: red). Activate the lever for the wing fold cylinder in the opposite direction (the cylinder is retracted).

Fig. 15

2. After a moment, a reading will be displayed on the manometer. Increase the pressure (retract the cylinder on the minus side of the cylinder) until approx. 15 bar (A).

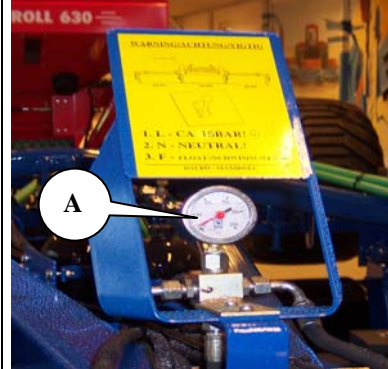

3. Set the cylinders in the floating position. The floating position is necessary to achieve hydraulic weight transfer, in which the sections are free to move individually.
4. It may be necessary to adjust the hydraulic weight transfer again. It might also be necessary to operate the machinery at a higher or lower pressure, depending on soil conditions.

Too much pressure

- 1 The pressure on the outermost wing sections will be too great. There will be clearly visible ridges on the outside of the wing sections.
- 2 The middle section will not pack the soil sufficiently, which can be seen when the soil trailing behind the middle section is higher and it is not as compressed as that after the wing sections.

Too little pressure

- 1 There is not enough pressure on the outer steel cylinder roller of the wing sections to press the steel cylinder roller sufficiently for an even field finishing.
- 2 The middle section packs the soil too heavily, which can be seen when the soil after the middle section is left much more compressed than that worked by the wing sections.



For the durability of Maxiroll Greenline and for the result in the field, it is very important that Maxiroll Greenline is set in floating position when working in the field.



Incorrect use of Maxiroll Greenline, as not setting the implement in floating position, can in worse cases cause breakdown on the implement as breach on the mainframe.

Travel speed

A working speed between 6-10 km/hour is recommended, but always drive according to conditions.

Power requirements

Power requirements change according to soil type, terrain, travel speed.

Tabel 2, **Guidelines for power requirements in HP** (without Crackerboard)

Working width	630 cm
Power requirements hp	90-120 hk

Troubleshooting

Problem	Cause	Action
Too much pressure on middle section	<ul style="list-style-type: none"> Insufficient weight transferred to wing sections 	<ul style="list-style-type: none"> Activate the lever of the hydraulic wing fold, so that more pressure is transferred to the wings (see "Operating and Driving Instructions").
	<ul style="list-style-type: none"> The pressure is too high 	<ul style="list-style-type: none"> Adjust the hitch and the middle section (see "Adjusting hitch height" and "Adjusting middle section").
	<ul style="list-style-type: none"> Middle section is not horizontal 	<ul style="list-style-type: none"> Adjust the hitch and the middle section (see "Adjusting hitch height" and "Adjusting middle section").
Too much pressure on the outer edges of the wing sections	<ul style="list-style-type: none"> Insufficient pressure on the middle section 	<ul style="list-style-type: none"> Activate the lever of the hydraulic wing fold, so that more pressure is transferred to the middle section (see "Operating and Driving Instructions").
	<ul style="list-style-type: none"> The hitch is too low 	<ul style="list-style-type: none"> Adjust the hitch and the middle section (see "Adjusting hitch height" and "Adjusting middle section").
	<ul style="list-style-type: none"> Middle section is not horizontal 	<ul style="list-style-type: none"> Adjust the hitch and the middle section (see "Adjusting hitch height" and "Adjusting middle section").
Pressure falls on the manometer	<ul style="list-style-type: none"> Lever is not in the floating position 	<ul style="list-style-type: none"> Adjust the pressure on the weight transfer and move the lever to the floating position (see "Adjusting hydraulic weight transfer")
	<ul style="list-style-type: none"> Pilot operated check valve is defective Cylinder (set of seals) leak 	<ul style="list-style-type: none"> Set the weight transfer to 15 bar and move the lever into the floating position. Leave the Maxiroll Greenline in a stationary position for ½ hour. If the pressure falls, the pilot operated check valve is defective or there can be dirt in the valve (take the valve apart and clean the parts).
Wing sections do not follow the terrain	<ul style="list-style-type: none"> Hydraulic weight transfer system is not in the floating position 	<ul style="list-style-type: none"> Set the hydraulic weight transfer in the floating position (see "Adjusting hydraulic weight transfer")

Options

Your Maxiroll Greenline can be equipped with various types of optional equipment, depending on individual needs.

- Crackerboard
- Weed Harrow
- Integrated seed technology

Crackerboard

The greatest advantage of the Crackerboard lies in the fact that the tines can move independently and thus flex individually in response to counter pressure from land contours. This provides the user with greater flexibility than a levelling board, since the entire levelling unit does not have to be disturbed because of a single obstacle.

Fig. 16



Power requirements

Compared to a fixed levelling board, the Crackerboard does not require as much power, although it depends on how the Crackerboard is used.

Table 1, Power requirements of the Crackerboard in HP

Model	630	830
Hp	35 - 60	50 - 100



Moving as little soil as possible reduces fuel consumption and material wear.

Hose markings

Table 3. Hose markings

Cylinder	Colour	Service	Function
Depth adjustment	Green	Double-acting	To regulate the working depth of the Crackerboard

Adjusting tine angle

The working depth of the Crackerboard is hydraulically adjustable. The tine angle is adjusted manually by means of the spindles (A). The sides of the spindles are marked with numbers to facilitate uniform angle adjustment.

The tine angle will remain set regardless of the depth, since the tines are mounted in a parallelogram formation.

Fig. 17

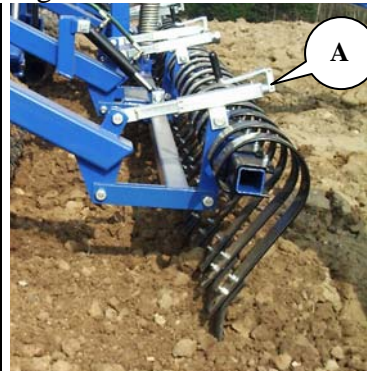

- For an **aggressive tine** (vertical tine), shorten the spindles.
- For a **passive tine** (tine lying down, lengthen the spindles).

Adjust tine angle to accommodate different field operations. If the tine is set aggressively and the penetration depth is set in the upper soil layer, the maximum amount of vibrations will be achieved to finely crush clods. This setting is recommended for most field work.

If the tine is lying down, it can more easily avoid obstacles. The point of the tine is also in a more Horizontal position, which gives a more uneven field surface.

Fine adjustment of Crackerboard and weed harrow sections

The Crackerboard is divided into three sections that all must work at the same depth. If the hitch height is changed, the alignment of the three Crackerboard sections is also changed.

The alignment of the sections and thus the depth of the tines must be adjusted the first time that Maxiroll Greenline is hitched to the tractor, and again if a different tractor is used. It is important that the levelling position of the Maxiroll Greenline is correct.

To level the Crackerboard unit, unfold Maxiroll Greenline on a flat surface and lower the Crackerboard until the points of the tines are just above the ground. All tines must have the same distance from the ground.

Operating and driving instructions

The Crackerboard is a versatile piece of equipment, with several application possibilities in one unit. At a depth setting of approx. 5 cm, the vibrating power of the tines will crush clods.

A deeper setting of the Crackerboard provides a greater levelling effect than a levelling board, as a small amount of soil builds up in front of the tines.

Fig. 18

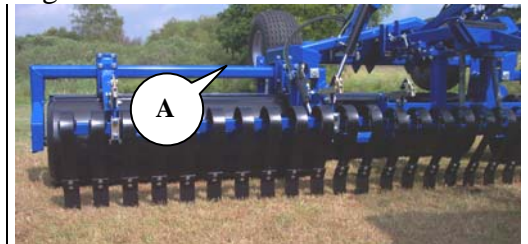

If the Crackerboard sections do not operate at uniform depth, it may be necessary to “reset” the Crackerboard by raising the board to the highest, top position.

Mounting after delivery

The Crackerboard can be mounted at the factory, but it can also be delivered at a later time if needed. A crane or similar equipment is required for mounting.

- 1 Unfold Maxiroll Greenline.
- 2 First mount the middle section to the flanges (A) of the drawbar.

Fig. 19



- 3 Mount the side sections to the flanges of the wing gangs (A).
- 4 Mount the hydraulic cylinders.
- 5 Connect the hoses to the cylinders.

Fig. 20



- 6 Tighten the clamp holding the hoses (A) and insert the hoses through the hose clamps on the drawbar.
- 7 Tighten all fittings and connect the Crackerboard to the hydraulic system of the tractor.

Fig. 21

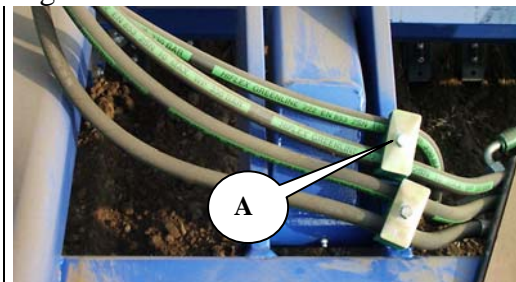



It is important to thoroughly bleed air out of the system to avoid personal injury. Move the depth adjustment cylinders up and down to the fully extended position several times to get air out of the system.

Locking Kit

As an accessory to the Crackerboard, a locking kit is available. The locking kit interlocks the tines into a long board divided into three sections. The Crackerboard will then function more like a levelling board.

Mounting

Mount the locking kit to the back-side of the tines with wearing points, using longer bolts. The tines are fastened together with a fastening plate (A), that is held together with pins (B).

Fig. 22

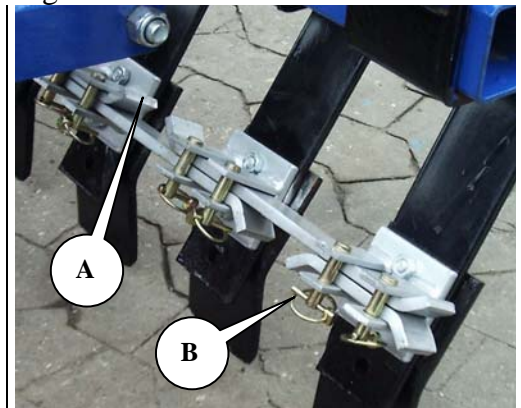

Comb, support wheel, moleboard

The equipment is used to tend and establish new grass areas and functions in the following way. A spring loaded and height adjustable moleboard (A) is mounted at the front of each section, which levels the surface. A height adjustable support wheel (B) is mounted after this, which ensures a uniform work depth across the entire comb section.



It is important to allow the comb sections to run freely on the support wheel, i.e. the hydraulic system (green hose) must be in a floating position when the harrow is working the earth.

Fig. 23

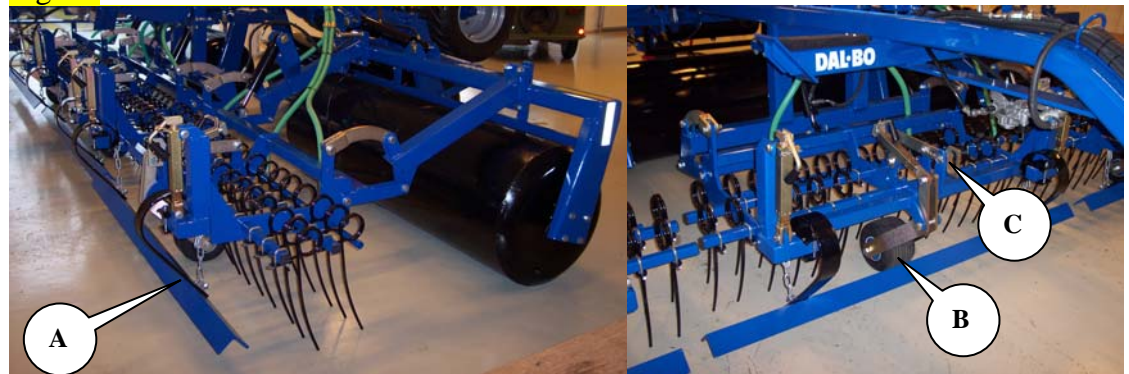

The aggressiveness of the comb's teeth is adjusted using the handle (C). If the teeth are too aggressive when planting the process can be adjusted!

Please see the user guidance for servicing the sowing machine.

Maintenance

Proper maintenance ensures a long life for the Maxiroll Greenline and also optimum performance from the implement. To facilitate maintenance, grease fittings have been mounted on those locations where wear on the equipment is the greatest.



Tighten all nuts, bolts, hydraulic fittings or any other fastened assemblies after the first workday. Inspect all pins and bolts for wear or damage and make sure that all are securely in place to avoid any possible damage or breakdown of the machine. Check for leaks in the hydraulic system.

Lubrication

Fig. 24

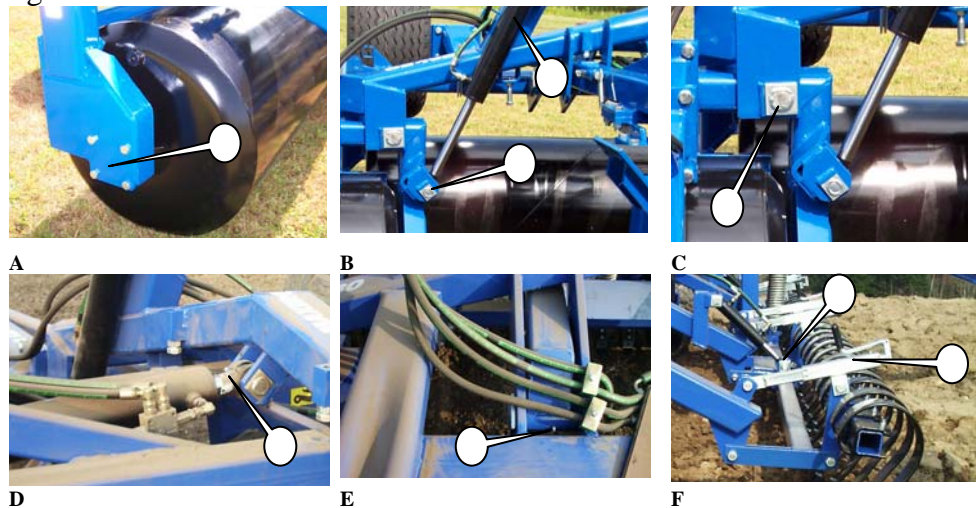

Lubrication points	Number of fittings	Lubrication interval (hours)	Photo
Flange bearings	6	50	A
Cylinder for wing folding/unfolding	4	25	B
Centre pin for unfolding of wings	2	25	C
Tilting cylinder	2	50	D
Centre pin for tilting	2	50	E
Crackerboard cylinder	2/6	50	F
Crackerboard spindle	6	100	F
Wheel bearings	2	200	



Lubricate all lubrication points at least once a year.

Adjustment

Wheels

Lubricate and adjust the wheel bearings once a year. Make sure that the tyre pressure is correct (see tyre).

Adjustment and lubrication of wheel bearings

1. Remove the hubcap.
2. Take out the split pin.
3. Tighten the castle nut $1/6$ of a rotation until the hole is lined up with the axle. The wheel must be able to rotate freely. There should be a little slack in the hub when the wheel is moved from side to side. If there is a lot of slack in the hub, repeat the process.
4. Replace the pin.
5. Fill the hubcap $3/4$ full with lubricant and reinstall.

Wearing points

The points are mounted into the highest holes of the tines at the factory. Move the points into the lowest holes (A) before the tines start to wear.

After the points are worn, while in the lowest holes, replace the points.

Fig. 25

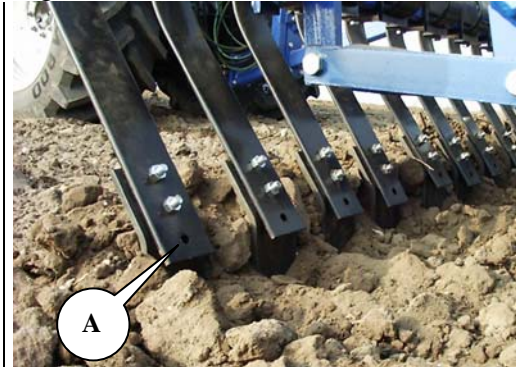

Scrapers

Adjust the scrapers by loosening the bolts (A), so that the scrapers can be moved. Adjust the scrapers so that there is a minimum space of 5 mm between the scrapers and the discs, but make sure that the scrapers never touch the discs.

Scrapers

The scrapers must be adjusted according to use.

1. Loosening the bolts (A) and adjust the scrapers by pushing it closer to the steel cylinder. The scrapers must not be in contact with the steel cylinder.
2. Tighten the bolts again

Fig. 26

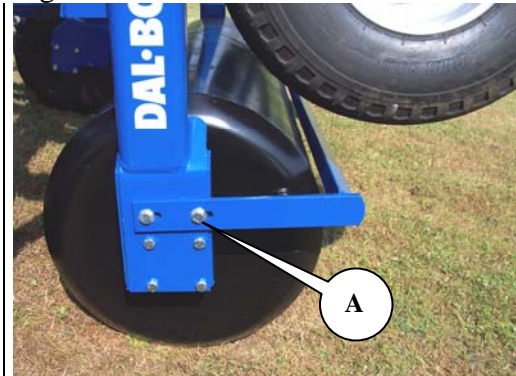

Hydraulic System



Inspect all hydraulic hoses for chafing or leaks. Check hoses for pinching.



To avoid rust, any projecting piston rods should be coated with oil or grease if the Maxiroll Greenline is to be parked for a long period of time. Remember to remove the oil or grease prior to operation.

Replacements and Repairs



Safety is important in connection with **all** repair work on the Maxiroll Greenline. The following safety precautions and the precautions listed in the beginning of this manual must be observed.



When changing the cylinders, always fill the cylinders with oil before putting pressure on them. For best results, first mount the cylinder into the part permanently attached to the Maxiroll Greenline frame, fill the cylinder with oil and then mount the opposite side.



Before performing any adjustments, maintenance or repairs on the machinery, always unfold the Maxiroll Greenline and lower the implement to the ground or secure in transport position, set the tractor brakes, turn off the engine and remove the ignition key to avoid unintentional operation.



Pay careful attention to safety when performing repair work on the hydraulic system. Remove hydraulic pressure prior to doing any maintenance, and block the part if needed.



After making repairs to the hydraulic system, always bleed air out of the system before operating the Maxiroll Greenline again to avoid any possible personal injury or mechanical breakdown or damage.

Hydraulic system

Changing wing fold cylinders

When performing repairs, make sure the Maxiroll Greenline is unfolded and resting on the ground.

1. Relieve the pressure in the cylinders. **Make sure the no pressure is displayed on the manometer.**
2. Disconnect the hoses.
3. Remove the split cotter pins and the other pins. The cylinders are now free.
4. Install new or repaired cylinders. Remember to make sure that the pin is engaged in the stop and that the pins are secured with split cotter pins.
5. Connect the hoses. After connection, make sure that there is no danger of the hoses becoming ripped off or pinched.

Fig. 27





After mounting the cylinder, activate the wing fold cylinders until the piston rods begin to move in the cylinders. Next, activate the cylinders in the opposite direction until the cylinder is back in the starting position. Move the cylinders several times in this way. Then move the Maxiroll Greenline up onto the wheels and unfold the wing sections out into the fully extended position to bleed air out of the system.



Never allow bystanders within the operating radius of the implement.

Replacing wing fold cylinder seals

Fig. 28

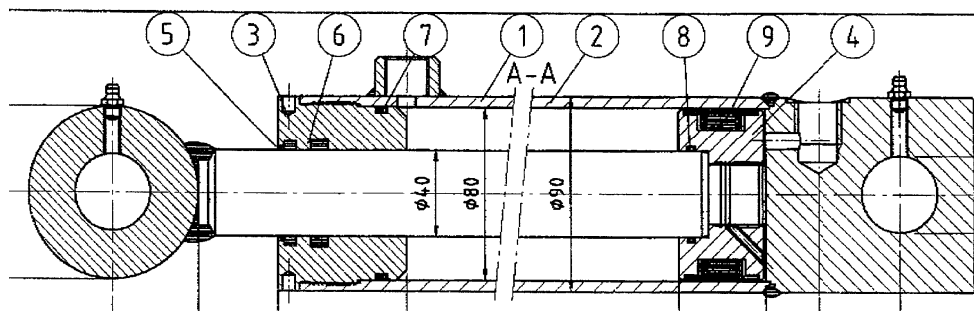

Cylinder 80/40-350 (91805)

1. For removal of the cylinder, see "Changing wing fold cylinders".
2. Empty the oil from the cylinder by moving the cylinder back and forth.
3. Move the piston to the middle position. Unscrew the gland (pos. 3) from the cylinder casing (pos. 1). (A special tool is needed to remove the gland). If the gland is stuck, it may help to warm up the very front of the socket. When the gland has been unscrewed, pull the piston towards the gland. Pull the piston rod completely out of the cylinder casing.
4. Remove the self-locking nut (pos. 4) holding the sleeve.
5. Pull the sleeve (pos. 4) off the piston rod.
6. Pull the gland (pos. 3) off the piston rod.
7. Remove the seals from the gland and the sleeve (pos. 5+6+7+8+9).
8. Clean all parts thoroughly. Check for filings, shavings, burrs, and make sure that there is no rust around the scraper ring (pos. 5) in the gland. If rust is found, it must be removed.

Assembly

1. Assemble the new seals (pos. 5+6+7+8+9) into the gland and the sleeve. Make sure the seals are facing in the correct direction.
2. Lubricate the screw threads on the gland (pos. 3) and the cylinder casing with oil.
3. Mount the gland (pos. 3) onto the piston rod.
4. Mount the sleeve (pos. 4) and screw on the self-locking nut **with Loctite**. Make sure that the screw threads are completely clean and free from oil or other impurities before using Loctite. **Do not refill the oil for the first 12 hours after the application of Loctite.**
5. Lubricate the outermost seal of the sleeve that has contact with the cylinder casing and the inside of the cylinder casing, then guide the piston rod into the middle position of the casing.
6. Screw the gland onto the casing and tighten.
7. Mount the cylinder (see "Changing wing fold cylinders").

Changing tilting cylinder

Unfold the Maxiroll Greenline and relieve the pressure in the tilting cylinder (A). (There are two tilting cylinders on the larger models).

Fig. 29

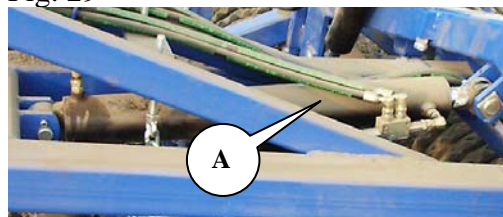

1. Disconnect the hoses from the cylinder.
2. Support the cylinder.
3. Remove the split cotter pins and the pins.
4. The cylinder is now free and can be dismantled.
5. Mount a new or repaired cylinder.



After mounting the cylinder, activate the wing fold cylinders until the piston rods begin to move in the cylinders. Next, activate the cylinders in the opposite direction until the cylinder is back in the starting position. Move the cylinders several times in this way. Then move the Maxiroll Greenline up onto the wheels and unfold the wing sections out into the fully extended position to bleed air out of the system.



Never allow bystanders within the operating radius of the implement.

Replacing tilting cylinder seals

Fig. 30

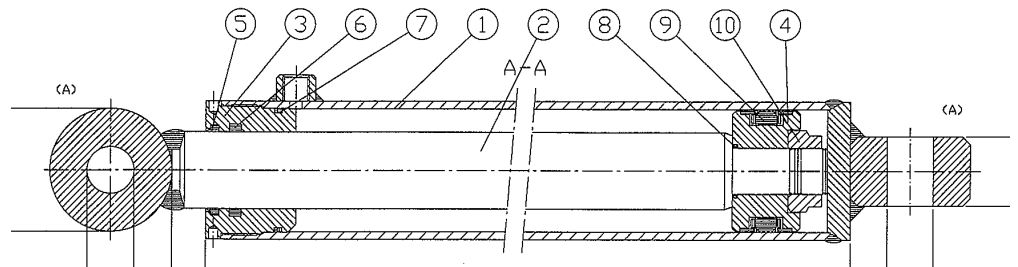

1. Empty the oil from the cylinder by carefully moving the cylinder back and forth.
2. Move the piston to the middle position. Unscrew the gland (pos. 3) from the cylinder casing (pos. 1). (A special tool is needed to remove the gland). If the gland is stuck, it may help to warm up the very front of the socket. When the gland has been unscrewed, pull the piston towards the gland. Pull the piston rod completely out of the cylinder casing (pos. 1).
3. Remove the self-locking nut (pos. 10) holding the sleeve (pos. 4).
4. Pull the sleeve (pos. 4) off the piston rod (pos. 2).
5. Pull the gland (pos. 3) off the piston rod (pos. 2).
6. Remove the seals from the gland and the sleeve (pos. 5+6+7+8+9).
7. Clean all parts thoroughly. Check for filings, shavings, burrs, and make sure that there is no rust around the scraper ring (pos. 5) in the gland. If rust is found, it must be removed.

Assembly

1. Assemble the new seals (pos. 5+6+7+8+9) into the gland and the sleeve.
2. Lubricate the screw threads on the gland (pos. 3) and the cylinder casing (pos. 1) with oil.
3. Mount the gland (pos. 3) onto the piston rod.
4. Mount the sleeve (pos. 4) and screw on the self-locking nut **with Loctite**. Make sure that the screw threads are completely clean and free from oil or other impurities before using Loctite. **Do not refill the oil for the first 12 hours after the application of Loctite.**
5. Lubricate the outermost seal of the sleeve that has contact with the cylinder casing and the inside of the cylinder casing, then guide the piston rod into the middle position of the casing.
6. Screw the gland onto the casing and tighten.
7. To mount the cylinder, (see "Changing wing fold cylinders").

Changing Crackerboard depth adjustment cylinder

Fig. 31

1. The Maxiroll Greenline must be unfolded and resting on the ground.
2. Lower the Crackerboard and relieve the pressure in the hydraulic system.
3. Disconnect the hoses from the cylinders (A).
4. Remove the split cotter pins and the pins (B).
5. Mount a new or repaired cylinder.
6. Remember to secure the pins and the split cotter pins.

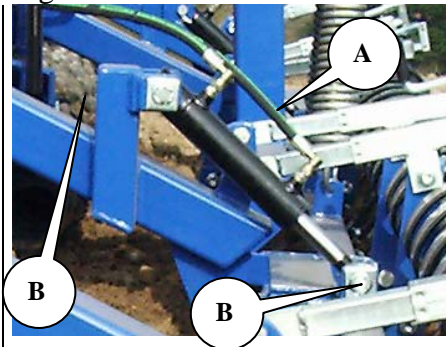

After reinstalling the cylinders, and with the Maxiroll Greenline in an unfolded position, move the depth adjustment cylinders up and down several times to bleed air out of the system.

Replacing depth adjustment cylinder seals

Fig. 32

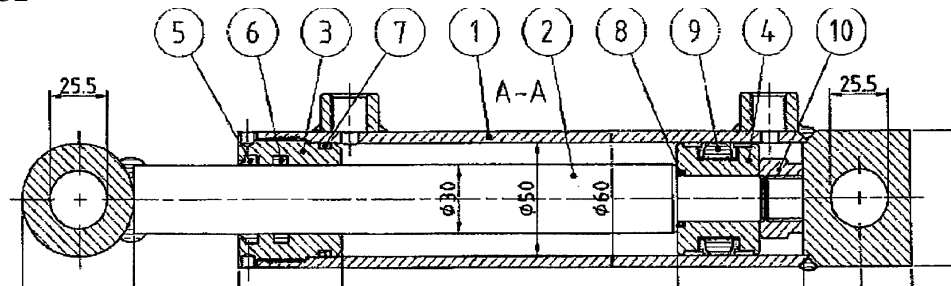

Cylinder 50/30-150

- 1 Empty the oil from the cylinder by carefully moving the cylinder back and forth.
- 2 Move the piston to the middle position. Unscrew the gland (pos. 3) from the cylinder casing (pos. 1). (A special tool is needed to remove the gland). If the gland is stuck, it may help to warm up the very front of the socket. When the gland has been unscrewed, pull the piston towards the gland. Pull the piston rod completely out of the cylinder casing (pos. 1).
- 3 Remove the self-locking nut (pos. 10) holding the sleeve (pos. 4).
- 4 Pull the sleeve (pos. 4) off the piston rod (pos. 2).
- 5 Pull the gland (pos. 3) off the piston rod (pos. 2).
- 6 Remove the seals from the gland and the sleeve (pos. 5+6+7+8+9).
- 7 Clean all parts thoroughly. Check for filings, shavings, burrs, and make sure that there is no rust around the scraper ring (pos. 5) in the gland. If rust is found, it must be removed.

Assembly

- 1 Assemble the new seals (pos. 5+6+7+8+9) into the gland and the sleeve.
- 2 Lubricate the screw threads on the gland (pos. 3) and the cylinder casing (pos. 1) with oil.
- 3 Mount the gland (pos. 3) onto the piston rod.
- 4 Mount the sleeve (pos. 4) and screw on the self-locking nut **with Loctite**. Make sure that the screw threads are completely clean and free from oil or other impurities before using Loctite. **Do not refill the oil for the first 12 hours after the application of Loctite.**
- 5 Lubricate the outermost seal of the sleeve that has contact with the cylinder casing and the inside of the cylinder casing, then guide the piston rod into the middle position of the casing.
- 6 Screw the gland onto the casing and tighten.
- 7 To mount the cylinder, see "Changing Crackerboard depth adjustment cylinder".

Dismounting/mounting of wheels

To dismount the wheels, lower the Maxiroll Greenline until the discs are resting on the ground and the wheels are clear off the ground.

Remove the lug nuts. The wheel can then be removed. After mounting a new wheel, screw on the lug nuts and tighten with a "hard hand". Next, lower the wheels until they are touching the ground and tighten the nuts to a torque of 300 Nm.



It is important that the wheel lug nuts and the mounting surface of the rim are clean; otherwise the nuts will become loose.

Changing wheel bearings

1. Remove the hubcap (pos. 21).
2. Take out the split cotter pin (pos. 20).
3. Unscrew the castle nut (pos. 19).
4. Knock the hub off the axle (pos. 2).
5. Remove the bearings (pos. 17+18).
6. Remove the seal (pos. 19).

Fig. 33

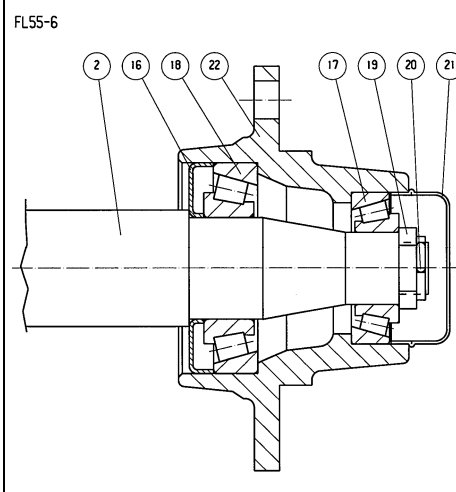

Assembly

1. Mount the outer rings of the bearings (pos. 17+18) into the hub (pos. 22).
2. Position the seal (pos. 16).
3. Place the inner ring of the bearing (pos. 18) onto the axle (pos. 2) and mount the axle into the hub.
4. Place the inner ring of the bearing (pos. 17) onto the axle (pos. 2).
5. Screw the castle nut onto the axle (pos. 2) and turn the hub (pos. 22) at the same time. Tighten the castle nut until there is drag on the hub as it is turning. Next, loosen the castle nut a quarter turn or until the hub turns around easily.
6. Replace the split cotter pin (pos. 20).
7. Fill the hubcap (pos. 21) half full with ball bearing grease and reinstall.

Dismounting Steel cylinder

Carry out all repairs on level ground. The Maxiroll Greenline must be hitched to a tractor and unfolded, with the steel cylinder roller resting on the ground. It would be a great help to have a crane or a similar machine available for both dismounting and mounting operations.

Changing wing steel cylinder roller

If no crane is available, both wing steel cylinder must be dismounted so that the roller does not fall.



Fig. 34

1. Loosen the bolts (A).
2. Lift with straps on the square frame tube of the wing section until the bolts (A) are loose and can be removed.
3. Activate the tilting cylinder and tilt the Maxiroll Greenline up onto the wheels.
4. Steel cylinder roller can be rolled away from the roller.

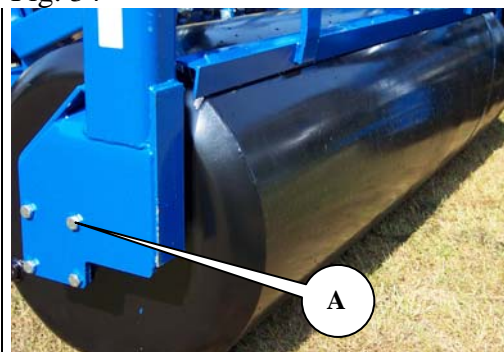

If no crane is available, Maxiroll Greenline's weight transfer can be activated slightly and moved into a position in which the bolts are loose and can be removed.

Mounting.

1. Place the steel cylinder roller with bearings in a position that is similar to that of the Maxiroll Greenline when it is unfolded.
2. Unfold the Maxiroll Greenline and carefully tilt down to the steel cylinder roller.
3. Replace the bolts (A).



Never allow bystanders within the operating radius of the implement when/if the hydraulic system is activated.

Changing the middle Steel cylinder roller

1. Loosen the bolts (A).
2. Activate the tilting cylinders and tilt Maxiroll Greenline until the wheels are resting on the ground and the bolts are loose.
3. Remove the bolts.
4. Tilt the Maxiroll Greenline until the wheels are lifted off the ground again, as high as they can move.
5. The steel cylinder roller can be rolled away from the roller.
6. Mount in reverse order.

Fig. 35

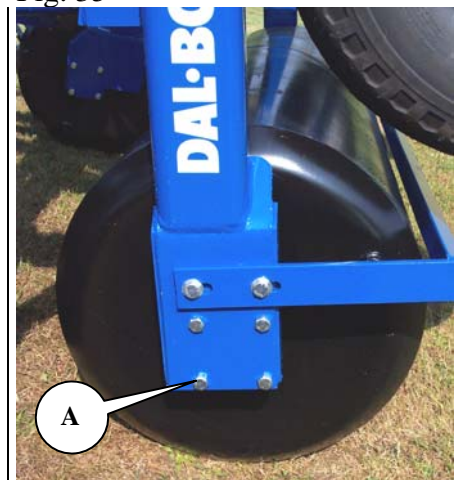

Never activate the hydraulic system when there are bystanders within the operating radius of the implement.

Scrapping



The Maxiroll Greenline must be unfolded. It is important to remove the pressure in **all** cylinders.



When dismantling/mounting components, always pay attention to the weight of the part that you are about to handle. It is **important** to support or secure the part so that it cannot fall.

Dismount all hydraulic hoses and cylinders and empty the oil. To avoid pollution of the ground and the surrounding area, collect as much oil as possible. Dispose of the oil and the hoses properly.

All iron used in the machine is recyclable.

Hydraulic System Diagram

Fig.36

Greenline 630+crackerboard

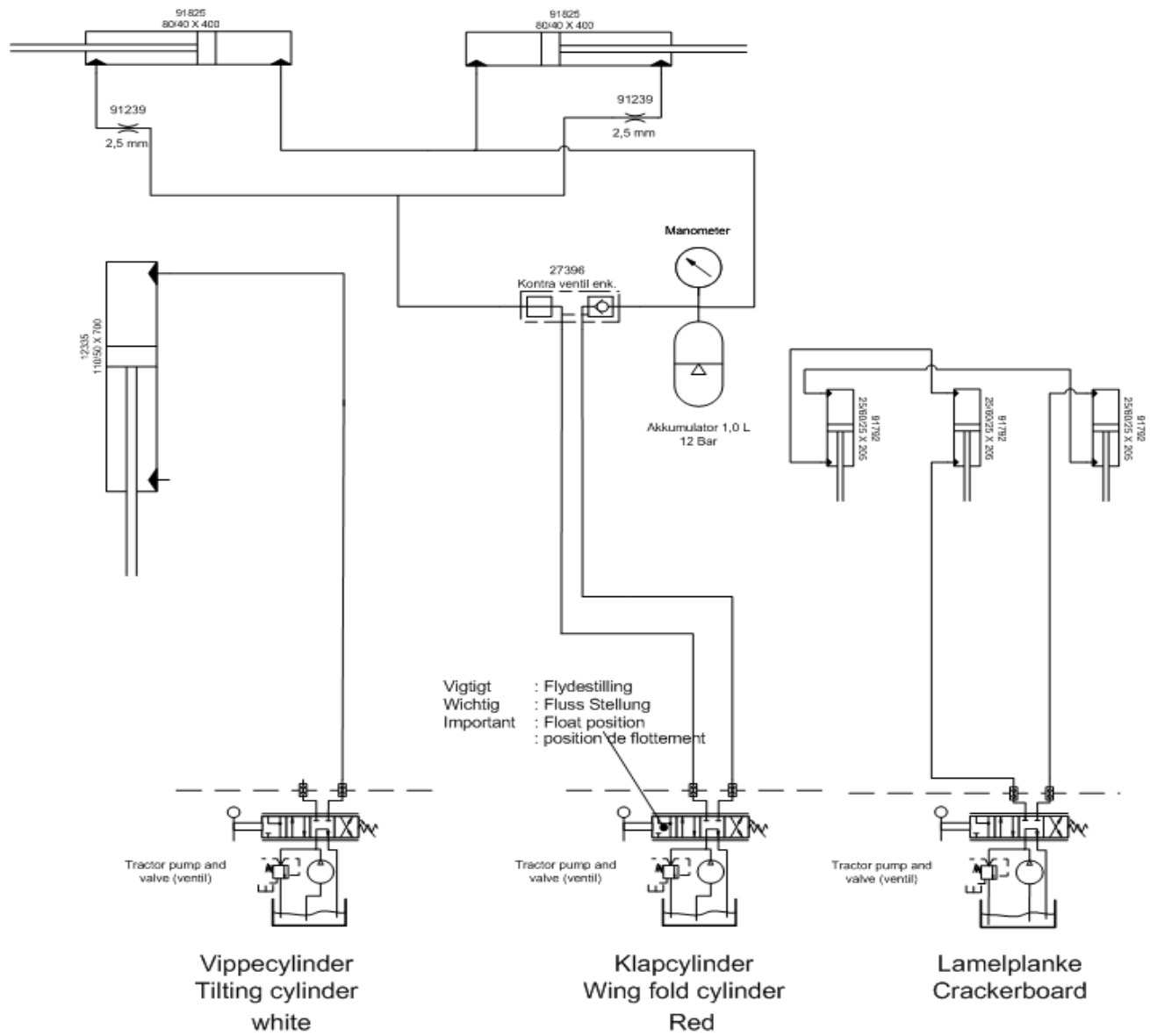



Spare Parts